

FLUX SMART OUTLET



User Guide

Document Number: T0006623 - FLUX

Document Version: V2

Release Date: 7 June 2024

Contents

1	Product Description	3
1.1	Overview.....	3
1.2	Specifications.....	3
2	Operating Instructions	5
2.1	Included Product and Accessories	5
2.2	Unpacking and Inspection.....	5
2.3	Installation Procedure	5
2.4	Commissioning	6
3	Operation	7
3.1	Smart Outlet.....	7
3.2	Remote Operation.....	7
3.3	Local Operation	7
3.4	LED Behaviour	7
4	Basic Downlinks.....	8
5	Data converters.....	10
6	Safety Precautions.....	11
7	Compliance Statements	12

1 Product Description

1.1 Overview

FLUX is a 120V Smart Outlet has the form factor of a standard NEMA 5-15R Decorator style duplex tamper-resistant receptacle (see Figure 1-1) but incorporates a LoRa radio with power control and monitoring circuitry which allows for the following remote user features:

- Power on-off control and status
- Precise measurement of:
 - consumed energy (kWh)
 - line voltage (Vrms)
 - load current (Arms)
 - load power (real, reactive, and apparent, W)
 - load power factor

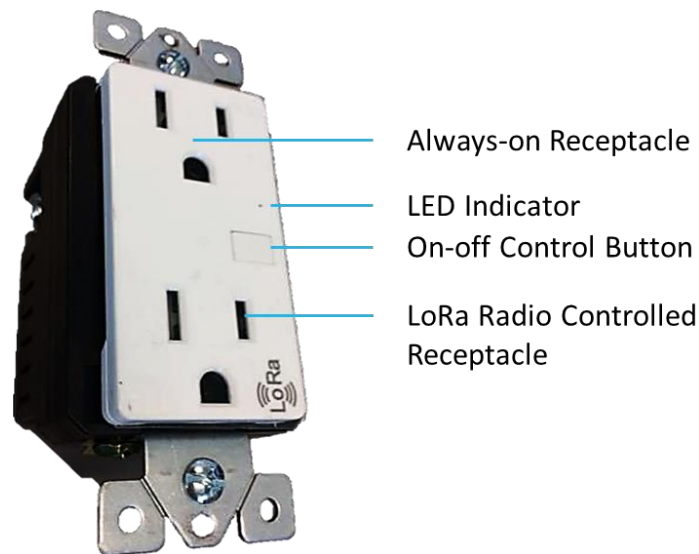

Figure 1-1 FLUX form factor

FLUX is a C-class device which means one can send a downlink to FLUX and get a reply in real time without the wait of an uplink to transmit the downlink. Connected via LoRaWAN, enables seamless transmission and reception in US915 frequency band.

This document provides comprehensive descriptions of FLUX Smart Outlet, along with detailed guidance on its hardware capabilities. For insights into the functional operation and software behavior, please consult the [Technical Reference Manual \(TRM\)](#) document.

1.2 Specifications

AURA specifications are listed in **Error! Reference source not found.** The main sensing functions are described in the following subsections.

Table 1-1: AURA Specifications

Parameter	Specification
Dimensions	43 mm (1.7") W x 46 mm (1.8") D x 104 mm (4.1") H
Weight	0.12 kg (0.26 lb)
Air Interface	LoRa US915 (902 - 928 MHz) Class C
Operating Control	Type 1.C Action
Environment	Indoor residential & commercial 0 to 40 °C (-40 to 104°F) 5 - 95% non-condensing RH Pollution Degree 2
Line	120 VAC, 60 Hz, 15 A circuit
Load	1800 W (15 A) Resistive 1000 W Incandescent 5 A Electronic ballast 1200 VA Standard ballast ½ HP Motor
Wire Termination	Max. 2 wires per terminal except 1 wire for Ground #14 - #12 AWG copper or copper clad solid conductor 16 mm (5/8") strip length Torque terminal screw to 2.3 N.m (20 lbf-in)
Surge Prot.	IEEE C62.41 Category A
Impulse Voltage	2500 V
Approvals	cUL (E515077) FCC Pt. 15, RSS-247, FCC Pt. 27

2 Operating Instructions

2.1 Included Product and Accessories

The following items are shipped with each sensor:

- 1x FLUX Smart Outlet device.
- 1x corresponding device Quick Start Guide.

NOTE: to ensure safe installation and maintenance please read [Safety Precautions](#).

2.2 Unpacking and Inspection

The following should be considered during the unpacking of a new sensor.

1. Inspect the shipping carton and report any significant damage to TEKTELIC.
2. Unpacking should be conducted in a clean and dry location.
3. Do not discard the shipping box or inserts as they will be required if a unit is returned for repair or re-configuration.

2.3 Installation Procedure

The following steps are required to install FLUX:

1. Locate the electrical box into which the FLUX will be installed.
2. Remove power to the wiring by turning off circuit power at the circuit breaker or fuse panel.
3. Test the existing wiring to ensure that power has been removed.
4. Inspect the electrical box, a box depth of at least 2" is required. The electrical box may be metal or plastic but a plastic box will result in the best all-around RF performance.
5. Identify the appropriate wiring diagram for your installation situation. Common installation diagrams are described in Figure 2-1, other options are possible. Always follow appropriate electrical codes and regulations.
6. Strip wire insulation back 5/8" (16 mm) and maintain a straight conductor for each of the wires to be terminated to the switch module.
7. Connect the wires to the module in accordance with the wiring diagram by inserting the bare wire fully into the wire hole for each of the Line (Hot), Load (Neutral), and Ground terminals on the switch module.

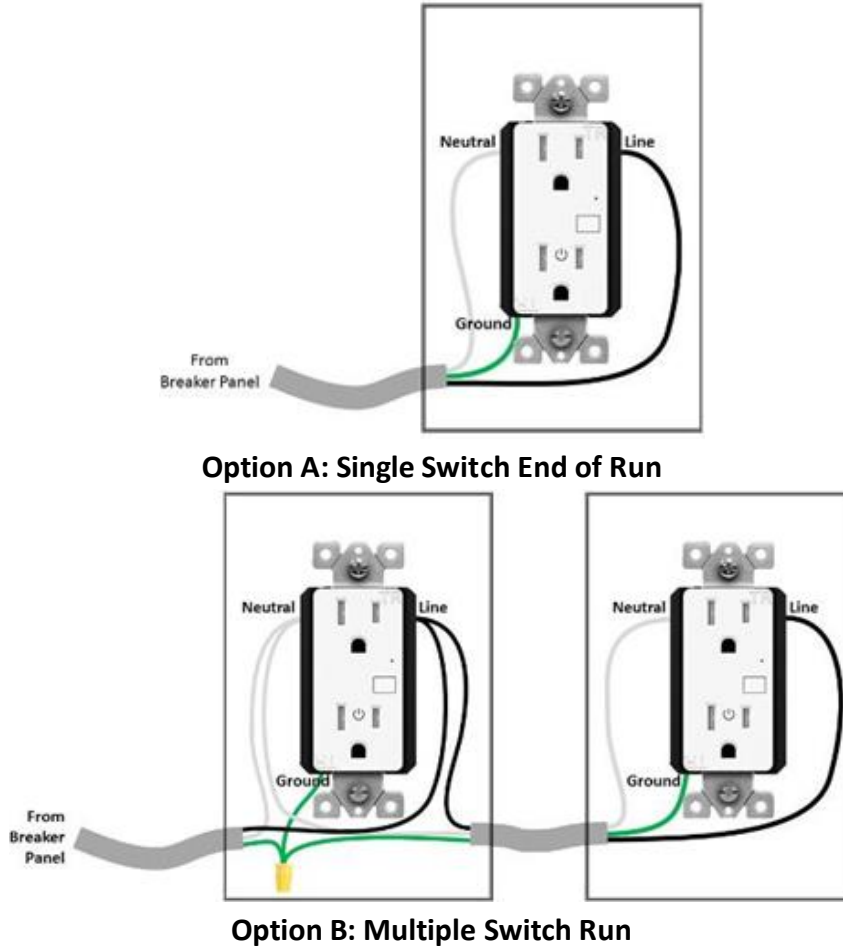

Figure 2-1 Wiring Diagrams

8. Once the module is fully wired, push the wiring and the module into the electrical box, secure the module with the two mounting ear screws, and install the trim plate with the two trim plate screws. Always use a plastic faceplate for best RF reception.
9. Reapply power to the circuit. The module faceplate LED will now begin to flash indicating connection to a LoRa network is underway.
10. Observe the load and test using the local on-off press button.
11. Commission the module as Class C device on the appropriate LoRa network.

2.4 Commissioning

Each sensor has a set of commissioning information that must be entered into the network server for the sensor to be able to join the network and begin normal operation once activated. For instructions on how to do this please refer to the Network Server Quick Start Guide you get in the box with the device (also available online in the [Knowledge Base](#)).

3 Operation

3.1 Smart Outlet

Only the lower receptacle is controlled and monitored, the top receptacle is always live when line power is connected to the module and any connected load does not contribute to the energy monitoring.

3.2 Remote Operation

The top outlet is always powered but doesn't count towards energy use tracking. Only the bottom outlet can be turned on or off remotely using LoRa. When the module is powered up, the bottom outlet stays off by default. You can control the bottom outlet's power remotely via LoRa.

Information available through the LoRa radio network:

- measurement of energy supplied to the connected load
- line voltage
- load current
- load power (real, reactive, and apparent)
- load power factor

For details please refer to the TEKTELIC Communications [Technical Reference Manual \(TRM\)](#).

3.3 Local Operation

The load of the bottom receptacle can be turn on or off by pressing the button. This load status change will be reported over the LoRa network. This load status change will be reported over the LoRa network and will be indicated on the blue LED.

3.4 LED Behaviour

The module faceplate has a Blue LED indicator:

Table 1-1: FLUX LEDs

LED	Description
On	Load power is OFF Module is connected to LoRaWAN
Off	Load power is ON Module is connected to LoRaWAN
90% On - 10% Off 1s cadence	Load power is OFF Module is connecting to LoRaWAN
10% On - 90% Off 1s cadence	Load power is ON Module is connecting to LoRaWAN

4 Basic Downlinks

FLUX use a "tick" system for reporting data. Generally, telemetry reporting time interval in seconds = core tick time interval * number of ticks per reporting.

There are two sets of settings that must be configured in conjunction - "Core reporting tick in seconds" and "Ticks per [data/report]". "Core reporting tick in seconds" will determine the interval between ticks. For example, you can set it to 60 seconds.

"Ticks per [data/report]" determines how many ticks it will take before the sensor reports any data. For example, if you set "Ticks per Power Meter" to 60, it will take 60 core ticks before the sensor reports battery data (You will see the report every hour".

To Change the Core Report to Every 15 Minute

Send the Downlink: a0 00 00 03 84 **port** 100.

FLUX doesn't have a decoder included in Atlas. However, it is possible to send the downlink in online mode as shown in the picture.

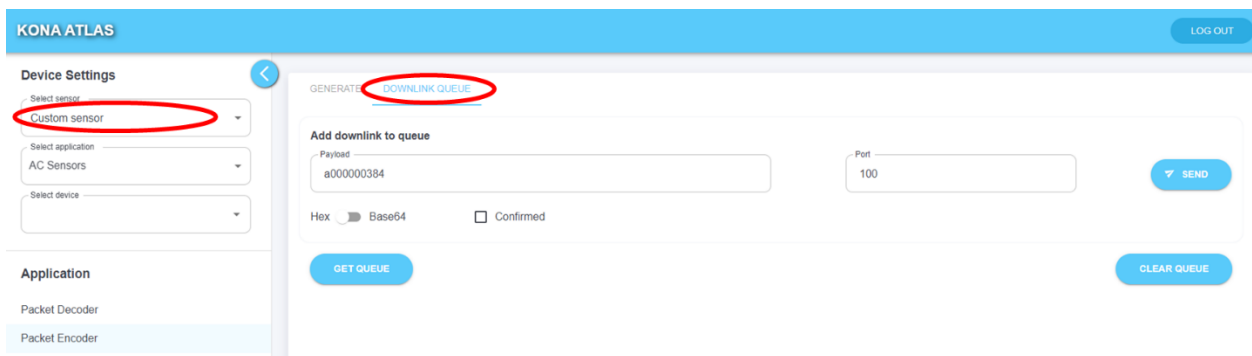

Figure 4-1 Downlink to change core report.

To close the relay

Send the Downlink: 000100 **port** 100.

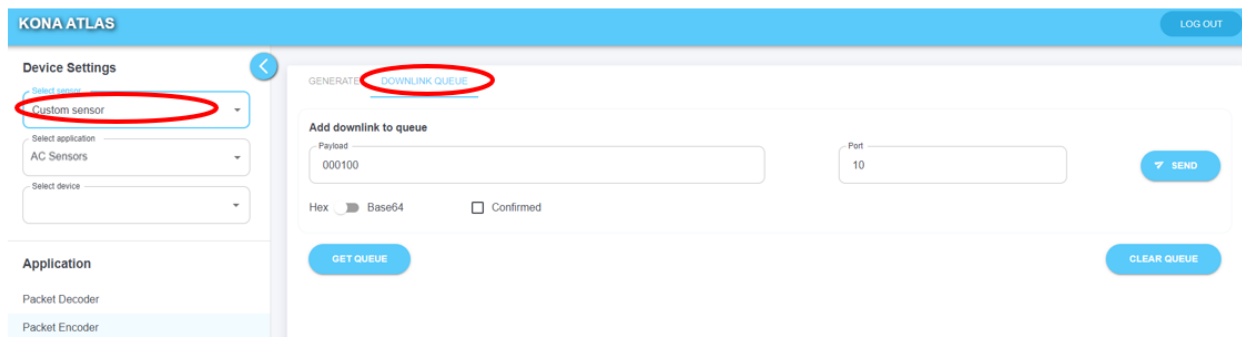

Figure 4-2 Downlink to close the relay

To open the relay

Send the Downlink: 0001ff **port** 100.

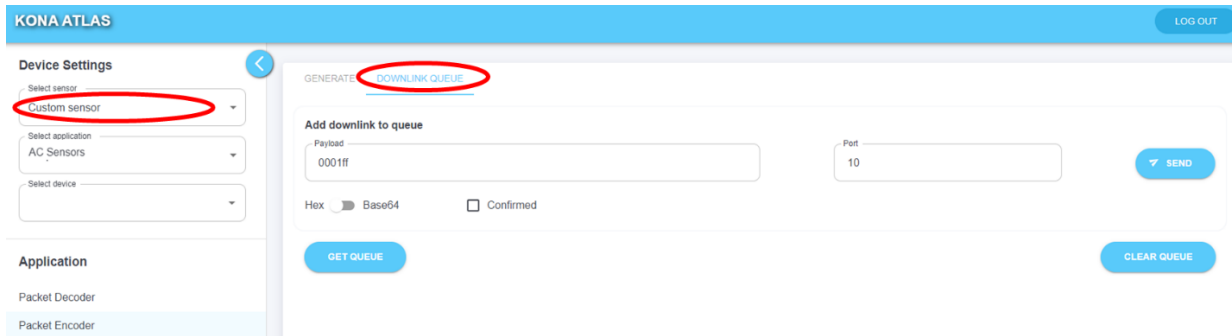

Figure 4-3 Downlink to open the relay

Examples Of Uplinks

0x00 0xFE 0x00 0x01 0x51 0x80 0x00 0x00 0x6A 0x50 0x00 0x00 0x00:

- Energy Consumption Meter:
 - Total elapsed time: 86400 seconds (= 24 hours)
 - Total energy consumed: 27216 W-h (= 27.216 kW-h)
- Energy Consumption Meter Status Indicator:
 - Status: Idle (stopped)

Example of data on LeapX

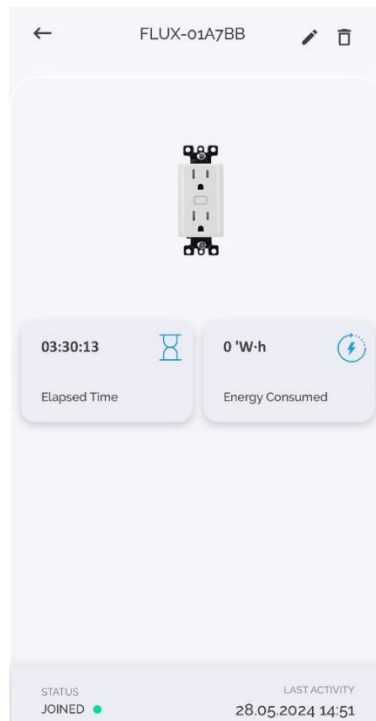

Figure 4-4 LeapX application

5 Data converters

Please follow this link: <https://github.com/TektelicCommunications/data-converters/tree/master> for the data converters that are to be used on TEKTELIC & other Network Server for TEKTELIC Sensors. These data converters can be used as a reference for other platforms.

TEKTELIC's data converters conform to the LoRa Alliance Payload Codec Specification and can be used with any 3rd party Network Server / Application Server that supports this specification.

<https://resources.lora-alliance.org/technical-specifications/ts013-1-0-0-payload-codec-api>

6 Safety Precautions

The following safety precautions should be observed for FLUX installation:

- TO AVOID FIRE, SHOCK, OR DEATH, ALWAYS TURN OFF POWER at the circuit breaker or fuse panel before wiring the module!
- If you are unsure or uncomfortable with installation of this module, consult an electrician.
- To be installed in a standard electrical box and used in accordance with appropriate electrical codes and regulations.
- To be installed with copper or copper clad wires only.
- Exercise caution when powering loads from the LoRa radio- controlled switch. Loads connected to this switch may be automatically powered on by a timer or by a remote user. Such unexpected operation may present a hazardous condition for local personnel.
- This product shall not be used with medical and/or life support equipment.

7 Compliance Statements

Federal Communications Commission:

This device complies with Part 15 of the FCC Rules. Operation is subject to the following two conditions:

1. This device may not cause harmful interference, and
2. This device must accept any interference received, including interference that may cause undesired operation.

To comply with FCC exposure limits for general population / uncontrolled exposure, this device should be installed at a distance of 20 cm from all persons and must not be co-located or operating in conjunction with any other transmitter.

Changes or modifications not expressly approved by the party responsible for compliance could void the user's authority to operate the equipment. This equipment has been tested and found to comply with the limits for a Class B digital device, pursuant to Part 15 of the FCC Rules. These limits are designed to provide reasonable protection against harmful interference in an industrial installation. This equipment generates uses and can radiate radio frequency energy and, if not installed and used in accordance with the instructions, may cause harmful interference to radio communications. However, there is no guarantee that interference will not occur in a particular installation. If this equipment does cause harmful interference to radio or television reception, which can be determined by turning the equipment off and on, the user is encouraged to try to correct the interference by one of the following measures:

- Reorient or relocate the receiving antenna.
- Increase the separation between the equipment and receiver.
- Connect the equipment into an outlet on a circuit different from that to which the receiver is connected.
- Consult the dealer or an experienced radio/TV technician for help.

Innovation, Science and Economic Development Canada (Industry Canada):

This device contains licence-exempt transmitter(s)/receiver(s) that comply with Innovation, Science and Economic Development Canada's licence-exempt RSS(s). Operation is subject to the following two conditions:

- i. This device may not cause interference, and

- ii. This device must accept any interference, including interference that may cause undesired operation of the device.

This device should be installed and operated with minimum distance 0.2 m from human body.

California Proposition 65:

 **WARNING:** This product can expose you to chemicals including lead, nickel, and carbon black, which are known to the State of California to cause cancer, birth defects or other reproductive harm. For more information, go to www.P65Warnings.ca.gov.